

Wind turbine - power generator **Dragon Hybrid**

User manual, warranty card



SAFETY INFORMATION

This device contains mechanical components that generate electricity and may pose a risk to life.

Therefore, the following conditions must be observed:

WARNING! It is your responsibility to obtain all necessary permits and plans for the mast location and installation. Soil and wind conditions are variable, and therefore the mast foundation must be individually selected for your location. The mast must be secured so that it cannot fall onto occupied buildings, power lines, etc. Climbing the mast is dangerous and should only be performed by experienced personnel using specialized equipment. The mast must be installed at an appropriate distance from occupied buildings and power lines.

WARNING! If the turbine operating on the mast appears unstable or is making unusual, unusual sounds, it must be repaired immediately. A damaged turbine or component may fail soon and fall from the mast, posing a life-threatening risk. Never stand in line with a rotating rotor.

WARNING! Secure the device to prevent unauthorized persons, especially children, from climbing on it. Never allow untrained personnel or anyone without proper safety equipment to climb the mast.

WARNING! Always stop the propeller before climbing the mast. Both a fall from the mast and contact with a rotating rotor can be fatal.

WARNING! The turbine should only be installed by a person with the appropriate SEP qualifications and a valid permit to work at height.

TECHNICAL SPECIFICATIONS

Turbine model:	Dragon Hybrid
Generator power:	1000W
Rotor diameter:	100cm
Turbine height:	250cm
Nominal voltage:	AC
Generator:	three-phase (3f) with neodymium magnets
Starting speed:	from 1.2 m/s
Wings and arms	The structure has been tested for durability in extreme conditions
Brake:	in the regulator / in the braking controller
Work system:	Off-grid, On-grid
Noise level according to the Standard PN-EN 61400-11:	<44dB at 8m/s
Operating temperature:	From -25 st. C up to 45 st. C
Types of masts:	Concrete and metal columns, trusses and roof bases
Compliance with the standard:	CE, IEC 61400
Photovoltaic panel power	140 W
Photovoltaic panel voltage	54 V

Point-wise power curve table for the Dragon 1000+ wind turbine

THRESHOLDS	RPM no load	DC [V]	AC [V]	Load [A]	Power [W]	RPM with a load	Voltage [V]
1	19	13	7	0,73	7	18	10
2	39	27	19	0,96	21	37	22
3	60	41	30	1,19	39	55	33
4	79	52	41	1,36	61	74	45
5	99	62	52	1,59	89	93	56
6	119	73	62	1,84	123	112	67
7	139	84	73	2,07	164	130	79
8	159	95	84	2,3	205	148	89
9	179	106	95	2,53	253	166	100
10	197	116	106	2,77	307	184	111
11	219	127	116	2,99	362	202	121
12	238	137	127	3,33	440	220	132
13	258	148	137	3,43	487	238	142
14	278	159	148	3,65	555	256	152
15	298	169	159	3,86	629	274	163
16	318	181	169	4,3	787	310	183
17	332	232	181	4,51	866	327	192
18	358	257	191	4,65	930	337	200
19	379	289	202	4,89	1032	356	211

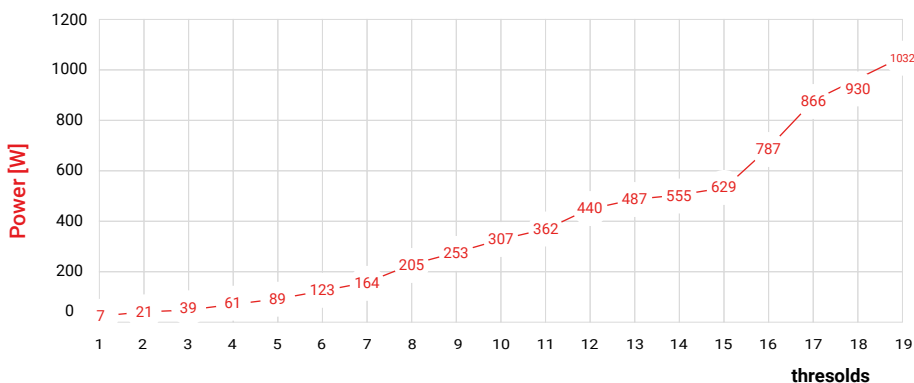
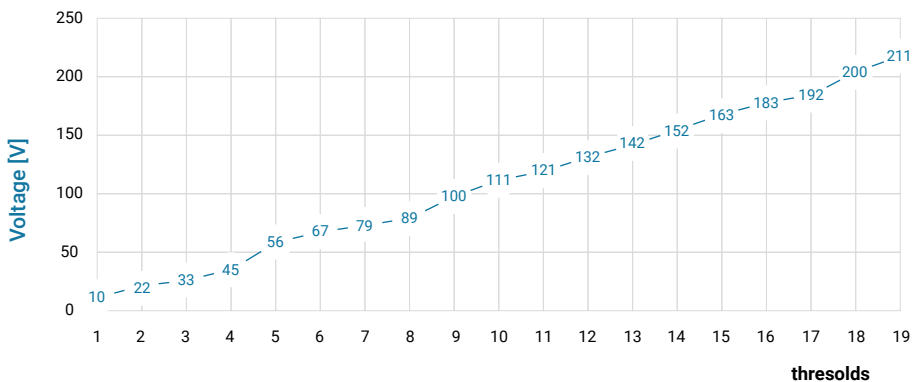
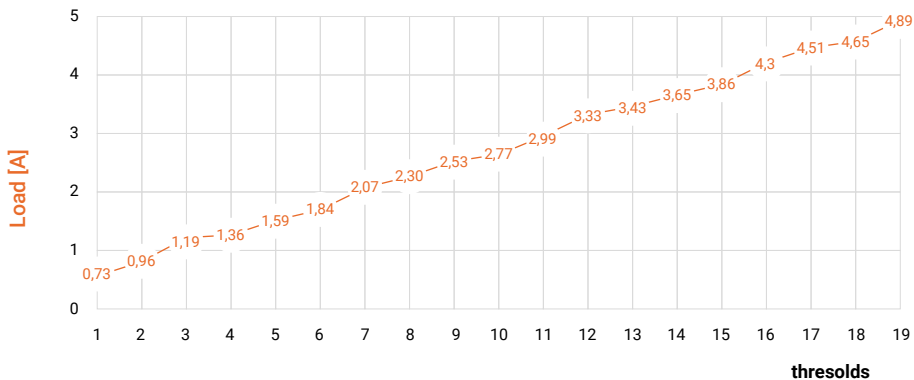

DRAGON WIND TURBINE

This is one of the world's most advanced wind battery charging devices. It is ideal for both off-grid and on-grid installations.

The device can supply energy to remote locations as well as small outbuildings. The turbine is easy to install.

Installation on a pitched roof

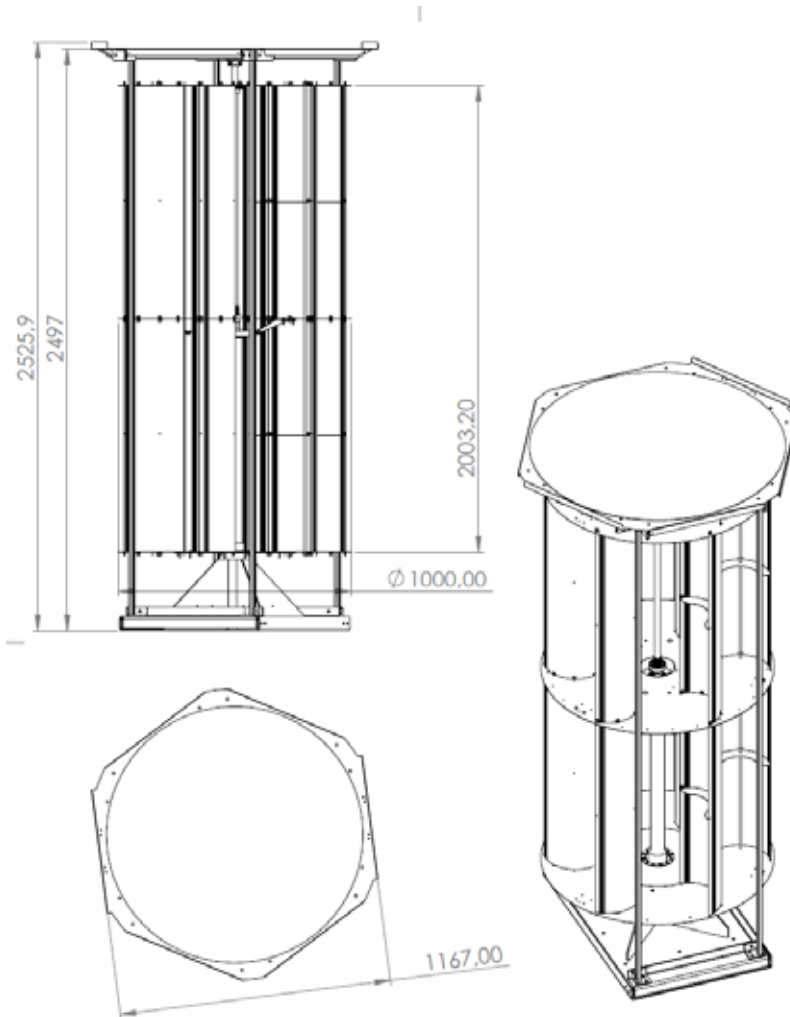

1

SAFETY MEASURES

1. The DRAGON wind turbine generator can generate life-threatening voltages.
2. Never allow the turbine to rotate without being connected to a suitable power source.
3. To avoid accidents, carefully plan the installation and arrange for assistance when erecting the device.
4. It is recommended to perform as much of the installation work as possible on the ground.
5. Whenever possible, choose a calm, dry day for installation.
6. The turbine generator is equipped with high-performance, permanently attached magnets, which can be damaged if mishandled (e.g., dropped).
7. The device must be fused at all times during operation.
8. Never approach the rotor blades during operation, as this can result in serious physical injury.
9. Always stop the turbine and secure the rotor blades before performing maintenance.

OPERATION OF THE DEVICE

Normal Operation

Battery charging begins once the minimum voltage in the power bank is reached at a given moment. As wind speed increases, the rotor will also spin faster, and the turbine will generate more electricity.

Operation should be regulated by a controller tailored to the installation's needs, ensuring optimal operation and adapting the charging power to the capacity and power of the existing installation. Dragon turbines are compatible with 24V or 48V controllers. The controller should be selected based on the wind speed in the specific location.

METHODS OF CONNECTING BATTERIES IN SERIES

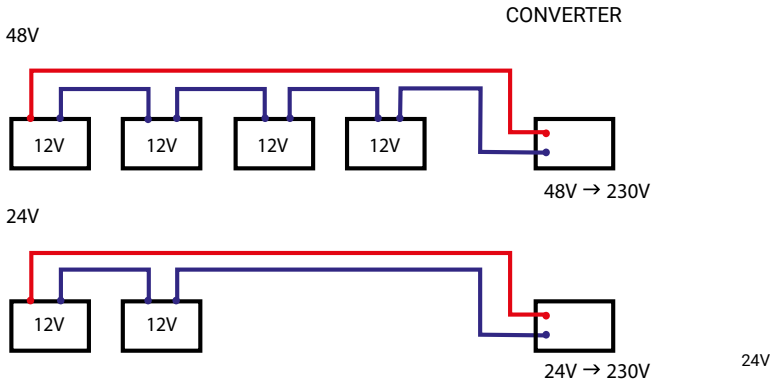

Examples of how to connect batteries depending on the voltage we want to achieve in our installation.

METHODS OF CONNECTING POWER BANK BATTERIES

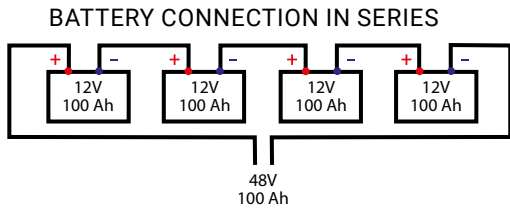

When connected in series, the voltage of the power bank increases

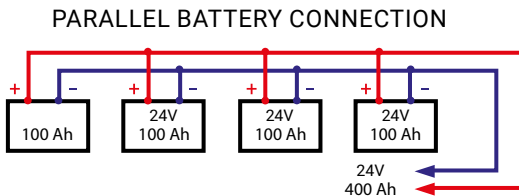

When connected in parallel, the capacity of the power bank increases

Example battery connection during power bank configuration. With the right connection, you can create an installation with different voltages and capacities.

WARRANTY

The DRAGON wind turbine has an 8-year manufacturer's warranty from DOSPEL.

TERITORIAL SCOPE

DOSPEL ensures proper operation of the DOSPEL DRAGON wind turbine in accordance with the technical and operating conditions attached to the warranty.

This warranty applies:

- within the territory of the Republic of Poland, and
- within the European Union and the European Economic Area (EU/EEA) – under the cross-border service procedure described in these terms.

Warranty service outside the territory of Poland may be provided:

- by the DOSPEL service department,
- by a service partner/installer designated or authorized by DOSPEL in the country of installation,
- in a mixed model (remote diagnostics + shipment of parts + local repair according to DOSPEL procedures), where technically justified.

WARRANTY COVERAGE

The warranty includes free-of-charge repair for a period of 8 years* from the date of purchase of the wind turbine.

Claims under the warranty arise on the date of purchase of the device and expire on the last day of the warranty period for the product. The warranty period is calculated from the installation date, but no longer than 10 years from the date of manufacture.

The warranty obliges DOSPEL to remedy, free of charge, hidden defects or defects resulting from the manufacturer's fault. Warranty repairs are performed by DOSPEL or by an entity designated by DOSPEL (e.g., a service partner).

This warranty does not exclude, limit or suspend the buyer's rights arising from non-conformity of the goods with the contract.

WARRANTY LIMITATIONS

The warranty period is shortened in the event of using parts or consumables from manufacturers other than the Guarantor:

1. to 2 years for consumers,
2. to 1 year for business customers.

THE WARRANTY BECOMES VOID IF DEFECTS OR DAMAGE ARE FOUND TO HAVE RESULTED FROM:

1. mechanical forces,
2. contamination,
3. modifications,
4. structural changes,
5. maintenance activities inconsistent with the operating manual,
6. accidents,
7. natural disasters,
8. chemical factors,
9. atmospheric factors (e.g., discoloration, corrosion),
10. improper storage,
11. unauthorized repairs,
12. incorrect installation of the device,
13. improper operation of the device,
14. use of consumables other than those of DOSPEL,
15. use of components for installation other than those of DOSPEL.

The warranty also becomes void in the event of breaking warranty seals, unless this resulted from required periodic service activities performed by the Guarantor or an entity designated by the Guarantor.

THE WARRANTY DOES NOT COVER:

1. consumables that wear out during normal use (e.g., gaskets, fuses),
2. activities related to inspections and normal operation,
3. losses resulting from downtime while waiting for repair,
4. costs of installation, cabling and other mounting elements,
5. claims resulting from incorrect calculations due to selection of technical parameters by the purchaser or subcontractor.

CUSTOMER RIGHTS ARE EXERCISED BY REMEDYING DEFECTS PRESENT IN THE DEVICE.

The term "repair" does not include activities provided for in the operating manual (start-up and operation), which the user is obliged to perform on their own.

VALIDITY OF THE WARRANTY CARD

The warranty card is valid if:

- it has been correctly completed (stamp and signature of the seller and date of sale),
- it is presented together with the proof of purchase.

In the event of loss of the warranty card, duplicates will not be issued.

SUBMITTING A WARRANTY CLAIM

A claim should be submitted by e-mail:

- to the company that installed the device, or
- if the claimant has proof of purchase/invoice for installation specifying the name and model of the DOSPEL DRAGON wind turbine – directly to the DOSPEL service department.

Claims may also concern installations outside Poland (EU/EEA). In such cases, DOSPEL may first perform remote diagnostics and then indicate the method of warranty service (on-site service visit, local partner, shipment of parts, repair at the service center).

REQUIRED INFORMATION

A claim must include:

1. the exact address of the place where the device is operated,
2. the turbine serial number,
3. a description of the damage found, symptoms of improper operation and—if possible—the name of the damaged component and photos.

COLLECTION, TRANSPORT, DISASSEMBLY AND REASSEMBLY

The claimed product will be collected by the DOSPEL service department or—if there are no logistical possibilities—via a freight company ordered by DOSPEL.

If transport is carried out via a freight company, the costs of disassembly and reassembly of the device are borne by the party entitled under the warranty. DOSPEL will reimburse justified costs approved by the Guarantor and documented with a VAT invoice—provided the claim is accepted.

For warranty service outside Poland, logistical costs (including international transport, service travel, disassembly and reassembly) may be subject to additional arrangements depending on local conditions and the nature of the claim; settlement rules apply in accordance with the “Warranty costs” section.

Unjustified service call-outs result in charging the cost of travel and the working time of the DOSPEL service technician.

PRODUCT REPLACEMENT

The product will be replaced with a new one if:

- DOSPEL determines that repair is impossible or economically unjustified,
- the same defect is repaired three times during the warranty period.

If the given model is unavailable, DOSPEL reserves the right to supply a device with similar parameters.

In the case of replacement of the device or major repairs, the warranty period starts anew from the date of delivery of the defect-free device or return of the repaired device.

WARRANTY COSTS

The full cost of repair is borne by DOSPEL.

If DOSPEL rejects the claim, the claimant will be charged the costs of transport and diagnostics.

10. ADDITIONAL INFORMATION

- DOSPEL provides warranty and post-warranty service.
- DOSPEL decides how the defect will be remedied.
- Any disputes shall be settled by the court having jurisdiction over DOSPEL's registered office.
- DOSPEL is not liable for any errors in the content of the warranty card.
- DOSPEL reserves the right to introduce changes in the documentation without affecting the basic parameters of the products.
- The wind turbine should be installed at the highest possible point on the property, without obstruction by vegetation, trees, buildings and similar objects.
- DOSPEL is not responsible for the selection of auxiliary equipment. Devices such as an inverter and controller should be selected each time to match the type of turbine, number of turbines, installation site and system choice.
- When connected to an energy storage system, the storage must be discharged to an appropriate level to enable power generation. If the storage is full and can also be charged from PV panels, power generation will not be possible.
- Before installing the turbine, it is recommended to measure wind conditions at the intended installation site for a minimum period of 4 months (e.g., the windy season November–February).
- During system configuration and wind turbine installation, the wind zone for the installation location should be verified. For this purpose, maps and data applicable to the country of installation or reference data indicated in the documentation may be used.

WARRANTY CARD NO.

date of submission and order number	date of repair	specification of materials and repair activities	fitter's number, signature

<p>MODEL: serial number: date of sale:</p> <div data-bbox="109 788 392 903" style="border: 1px solid black; padding: 5px; margin-bottom: 10px;"> seller 's stamp </div> <p>warranty card is an attachment to account no. date:</p> <div data-bbox="109 1008 392 1123" style="border: 1px solid black; padding: 5px;"> . signature and stamp of the repair shop </div>	<p>MODEL: serial number: date of sale:</p> <div data-bbox="425 788 707 903" style="border: 1px solid black; padding: 5px; margin-bottom: 10px;"> seller 's stamp </div> <p>warranty card is an attachment to account no. date:</p> <div data-bbox="425 1008 707 1123" style="border: 1px solid black; padding: 5px;"> . signature and stamp of the repair shop </div>	<p>MODEL: serial number: date of sale:</p> <div data-bbox="741 788 1023 903" style="border: 1px solid black; padding: 5px; margin-bottom: 10px;"> seller 's stamp </div> <p>warranty card is an attachment to account no. date:</p> <div data-bbox="741 1008 1023 1123" style="border: 1px solid black; padding: 5px;"> . signature and stamp of the repair shop </div>
--	--	--

BEARING SERVICE

Service date:
Service technician's stamp and signature:

Service date:
Service technician's stamp and signature:

Service date:
Service technician's stamp and signature:





DOSPTEL

- SINCE 1974 -

Decommissioning

The device should be decommissioned in the event of:

permanent mechanical damage,
damage to the generator or photovoltaic module,
further repair is uneconomical,
permanent deterioration of operational safety,
end of the manufacturer's intended service life.

Safe Disassembly Guidelines

Disassembly of the device should only be performed by persons with appropriate technical and electrical qualifications.

Before beginning disassembly, the following should be done:

disconnect the device from the electrical system,
disconnect the batteries or energy storage unit,
secure the rotor against movement,
disconnect the photovoltaic module according to the manufacturer's procedure,
mark and secure the work area.

Use extreme caution during disassembly due to the possibility of voltage on the DC side of the photovoltaic module.

Photovoltaic Module Handling - SINCE 1974 -

A photovoltaic module is considered electrical and electronic equipment. A used or damaged module must not be disposed of with municipal waste. The photovoltaic panel should be taken to an authorized collection point or treatment facility for waste electrical and electronic equipment.

Photovoltaic panels are covered by the EU WEEE/WEEE system, and the separate collection marking is a crossed-out bin symbol. This symbol must be displayed visibly, legibly, and permanently.

In Poland, the rules for handling waste electrical and electronic equipment are specified in the Act of September 11, 2015; used equipment is taken to the WEEE collection system, in practice, including municipal waste collection points or other authorized collectors.

Handling a Damaged Panel

In the event of a crack, leak, or other damage to a PV module, you should:

do not touch exposed conductive parts,
protect the area from unauthorized access,
disconnect the device in accordance with safety procedures,
hand over the damaged panel to an authorized entity.

A photovoltaic generator may still generate dangerous DC voltage when exposed to light.